



DISCRETE POWER DIODES and THYRISTORS
DATA BOOK

PHASE CONTROL THYRISTORS
Hockey Puk Version
Features

- Center amplifying gate
- Metal case with ceramic insulator
- International standard case TO-200AB (A-PUK)

Typical Applications

- DC motor controls
- Controlled DC power supplies
- AC controllers

Major Ratings and Characteristics

Parameters	ST280C..C	Units
$I_{T(AV)}$	500	A
	@ T_{hs}	55 °C
$I_{T(RMS)}$	960	A
	@ T_{hs}	25 °C
I_{TSM}	@ 50Hz	7850 A
	@ 60Hz	8220 A
I^2t	@ 50Hz	308 KA ² s
	@ 60Hz	281 KA ² s
V_{DRM}/V_{RRM}	400 to 600	V
t_q typical	100	μs
T_J	- 40 to 125	°C

500A

case style TO-200AB (A-PUK)

ST280C..C Series

ELECTRICAL SPECIFICATIONS

Voltage Ratings

Type number	Voltage Code	V_{DRM}/V_{RRM} , max. repetitive peak and off-state voltage V	V_{RSM} , maximum non-repetitive peak voltage V	I_{DRM}/I_{RRM} max. @ $T_J = T_J$ max mA
ST280C..C	04	400	500	30
	06	600	700	

On-state Conduction

Parameter	ST280C..C	Units	Conditions	
$I_{T(AV)}$ Max. average on-state current @ Heatsink temperature	500 (185)	A	180° conduction, half sine wave double side (single side) cooled	
	55 (85)	°C		
$I_{T(RMS)}$ Max. RMS on-state current	960	A	DC @ 25°C heatsink temperature double side cooled	
I_{TSM} Max. peak, one-cycle non-repetitive surge current	7850		t = 10ms	No voltage reappplied
	8220		t = 8.3ms	reappplied
	6600		t = 10ms	100% V_{RRM}
	6900		t = 8.3ms	reappplied
I^2t Maximum I^2t for fusing	308	KA ² s	t = 10ms	No voltage reappplied
	281		t = 8.3ms	reappplied
	218		t = 10ms	100% V_{RRM}
	200		t = 8.3ms	reappplied
$I^2\sqrt{t}$ Maximum $I^2\sqrt{t}$ for fusing	3080	KA ² √s	t = 0.1 to 10ms, no voltage reappplied	
$V_{T(TO)1}$ Low level value of threshold voltage	0.84	V	$(16.7\% \times \pi \times I_{T(AV)} < I < \pi \times I_{T(AV)})$, $T_J = T_J$ max.	
$V_{T(TO)2}$ High level value of threshold voltage	0.88		$(I > \pi \times I_{T(AV)})$, $T_J = T_J$ max.	
r_{t1} Low level value of on-state slope resistance	0.50	mΩ	$(16.7\% \times \pi \times I_{T(AV)} < I < \pi \times I_{T(AV)})$, $T_J = T_J$ max.	
r_{t2} High level value of on-state slope resistance	0.47		$(I > \pi \times I_{T(AV)})$, $T_J = T_J$ max.	
V_{TM} Max. on-state voltage	1.36	V	$I_{pk} = 1050A$, $T_J = 125^\circ C$, $t_p = 10ms$ sine pulse	
I_H Maximum holding current	600	mA	$T_J = 25^\circ C$, anode supply 12V resistive load	
I_L Max. (typical) latching current	1000 (300)			

Switching

Parameter	ST280C..C	Units	Conditions
di/dt Max. non-repetitive rate of rise of turned-on current	1000	A/μs	Gate drive 20V, 20Ω, $t_r \leq 1\mu s$ $T_J = T_J$ max, anode voltage $\leq 80\% V_{DRM}$
t_d Typical delay time	1.0	μs	Gate current 1A, $di_g/dt = 1A/\mu s$ $V_d = 0.67\% V_{DRM}$, $T_J = 25^\circ C$
t_q Typical turn-off time	100		$I_{TM} = 300A$, $T_J = T_J$ max, $di/dt = 20A/\mu s$, $V_R = 50V$ $dv/dt = 20V/\mu s$, Gate 0V 100Ω, $t_p = 500\mu s$

ST280C..C Series

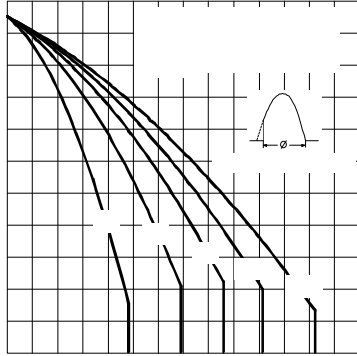

Fig. 3 - Current Ratings Characteristics

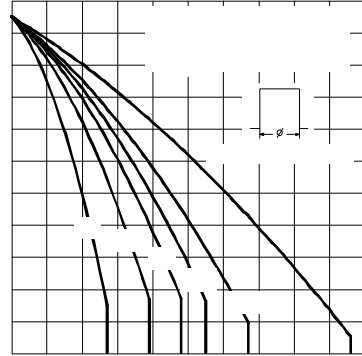

Fig. 4 - Current Ratings Characteristics

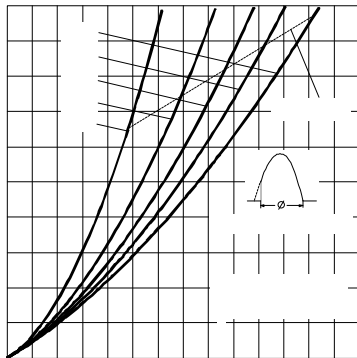

Fig. 5 - On-state Power Loss Characteristics

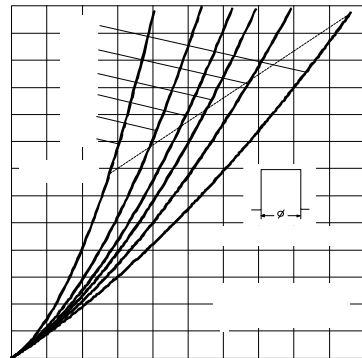

Fig. 6 - On-state Power Loss Characteristics

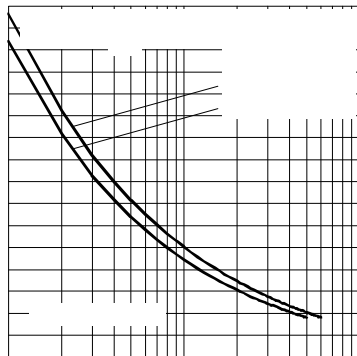

Fig. 7 - Maximum Non-Repetitive Surge Current
Single and Double Side Cooled

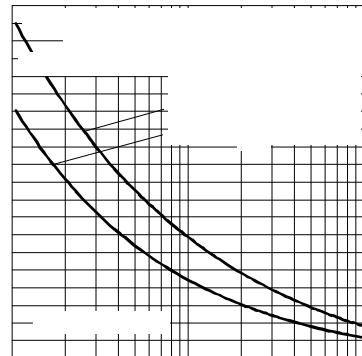

Fig. 8 - Maximum Non-Repetitive Surge Current
Single and Double Side Cooled

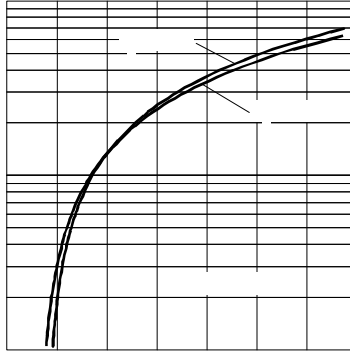

Fig. 9 - On-state Voltage Drop Characteristics

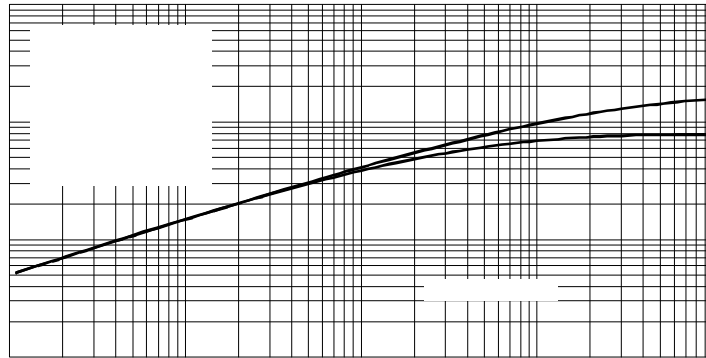

Fig. 10 - Thermal Impedance Z_{th-jhs} Characteristics

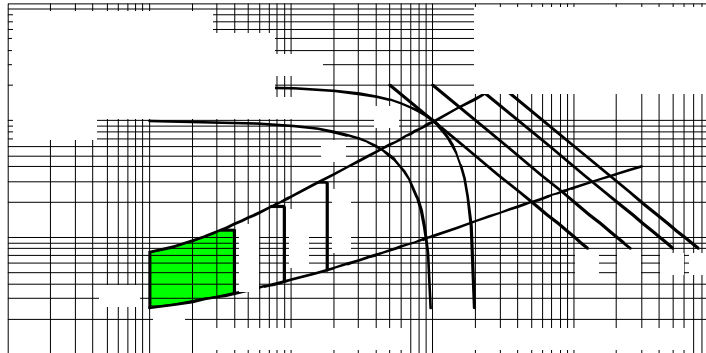

Fig. 11 - Gate Characteristics

Blocking

Parameter	ST280C..C	Units	Conditions
dv/dt Maximum critical rate of rise of off-state voltage	500	V/μs	T _J = T _J max. linear to 80% rated V _{DRM}
I _{DRM} I _{RRM} Max. peak reverse and off-state leakage current	30	mA	T _J = T _J max, rated V _{DRM} /V _{RRM} applied

Triggering

Parameter	ST280C..C	Units	Conditions
P _{GM} Maximum peak gate power	10.0	W	T _J = T _J max, t _p ≤ 5ms
P _{G(AV)} Maximum average gate power	2.0		T _J = T _J max, f = 50Hz, d% = 50
I _{GM} Max. peak positive gate current	3.0	A	T _J = T _J max, t _p ≤ 5ms
+V _{GM} Maximum peak positive gate voltage	20	V	T _J = T _J max, t _p ≤ 5ms
-V _{GM} Maximum peak negative gate voltage	5.0		
I _{GT} DC gate current required to trigger	TYP.	MAX.	T _J = - 40°C T _J = 25°C T _J = 125°C Max. required gate trigger/ current/ voltage are the lowest value which will trigger all units 12V anode-to-cathode applied
	180	-	
	90	150	
V _{GT} DC gate voltage required to trigger	2.9	-	T _J = - 40°C T _J = 25°C T _J = 125°C
	1.8	3.0	
	1.2	-	
I _{GD} DC gate current not to trigger	10	mA	T _J = T _J max Max. gate current/voltage not to trigger is the max. value which will not trigger any unit with rated V _{DRM} anode-to-cathode applied
V _{GD} DC gate voltage not to trigger	0.30	V	

Thermal and Mechanical Specification

Parameter	ST280C..C	Units	Conditions
T _J Max. operating temperature range	-40 to 125	°C	
T _{stg} Max. storage temperature range	-40 to 150		
R _{thJ-hs} Max. thermal resistance, junction to heatsink	0.17 0.08	K/W	DC operation single side cooled DC operation double side cooled
R _{thC-hs} Max. thermal resistance, case to heatsink	0.033 0.017	K/W	DC operation single side cooled DC operation double side cooled
F Mounting force, ± 10%	4900 (500)	N (Kg)	
wt Approximate weight	50	g	
Case style	TO - 200AB (A-PUK)		See Outline Table

ST280C..C Series

ΔR_{thJ-hs} Conduction

(The following table shows the increment of thermal resistance R_{thJ-hs} when devices operate at different conduction angles than DC)

Conduction angle	Sinusoidal conduction		Rectangular conduction		Units	Conditions
	Single Side	Double Side	Single Side	Double Side		
180°	0.016	0.016	0.011	0.011	K/W	$T_J = T_{J \text{ max.}}$
120°	0.019	0.019	0.019	0.019		
90°	0.024	0.024	0.026	0.026		
60°	0.035	0.035	0.036	0.037		
30°	0.060	0.060	0.060	0.061		

Ordering Information Table

Device Code							
ST	28	0	C	06	C	1	
①	②	③	④	⑤	⑥	⑦	⑧
1	- Thyristor	2	- Essential part number	3	- 0 = Converter grade	4	- C = Ceramic Puk
5	- Voltage code: Code x 100 = V_{RRM} (See Voltage Rating Table)	6	- C = Puk Case TO-200AB (A-PUK)	7	- 0 = Eyelet terminals (Gate and Auxiliary Cathode Unsoldered Leads)	1 = Fast-on terminals (Gate and Auxiliary Cathode Unsoldered Leads)	2 = Eyelet terminals (Gate and Auxiliary Cathode Soldered Leads)
8	- Critical dv/dt: None = 500V/μsec (Standard selection)	L	= 1000V/μsec (Special selection)				

Outline Table

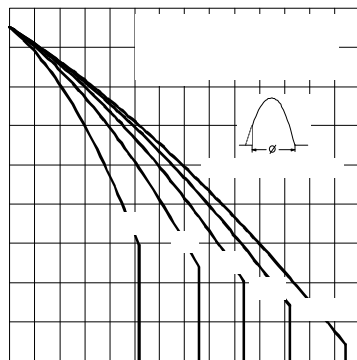
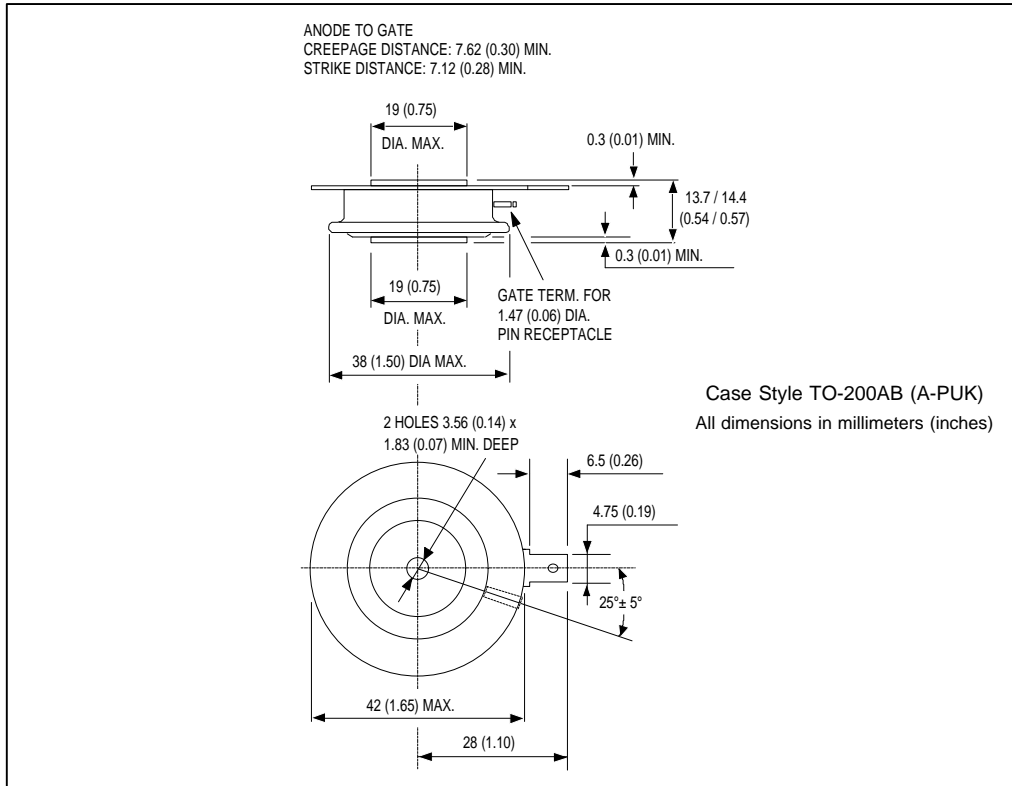

Fig. 1 - Current Ratings Characteristics

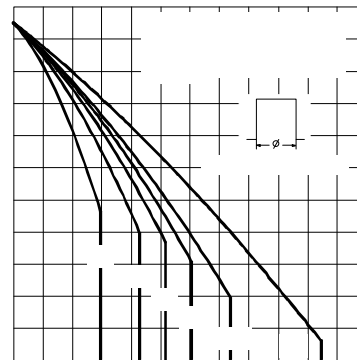

Fig. 2 - Current Ratings Characteristics